

**SteelFlex**

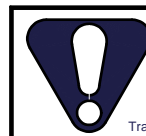
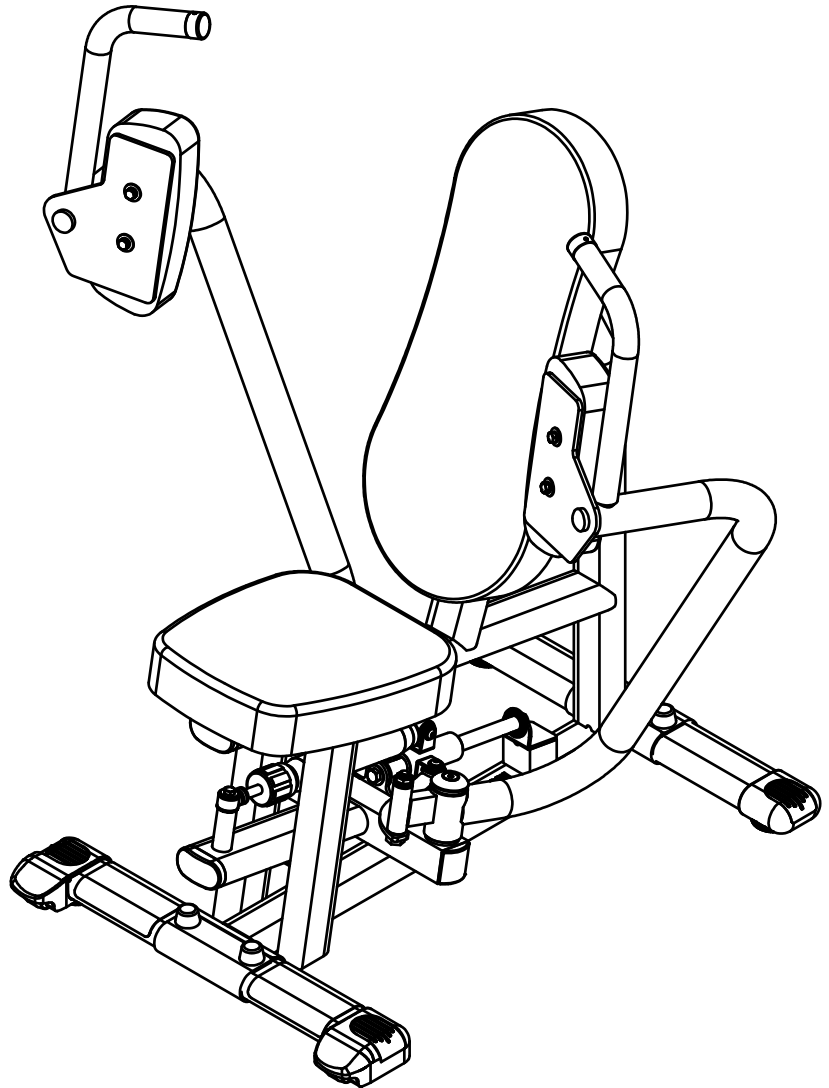

The Surgeon General  
has determined that lack  
of physical activity is  
detrimental to your health.™

Trademark of United States Fitness Products Council

THERE IS A RISK ASSUMED BY INDIVIDUALS WHO USE THIS TYPE OF EQUIPMENT. TO MINIMIZE RISK, YOU MUST FOLLOW THESE RULES:

1. Inspect equipment before each workout. Check that all nuts, bolts, screws and pop pins are in place and fully tightened. Also, before use, check cylinders for leaking. Replace all worn parts immediately. Never use machine if any parts are damaged or missing. Failure to follow these rules may result in serious injury.
2. Keep clear of the cylinder and all moving parts when the machine is in use.
3. Exercise with care. Perform your exercises at a smooth moderate pace; never perform jerky or uncoordinated movements that may cause injury.
4. It is recommended that you should workout with a training partner.
5. Do not allow children or minors to play on or around this equipment.
6. If unsure of proper use of equipment, call your local distributor.
7. **WARNING:** Consult your physician before starting your exercise program. For your own safety do not begin any exercise program without proper instruction.

**CPD-800.1 OWNER'S MANUAL**

# CPD-800 ASSEMBLY INSTRUCTIONS

## HARDWARE ILLUSTRATION

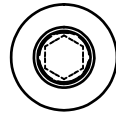
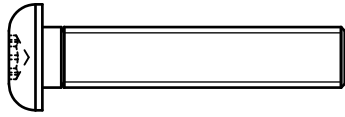

(A1)ROUND ALLEN HEAD M8x40L PARTIAL THREAD QTY.2

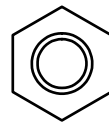
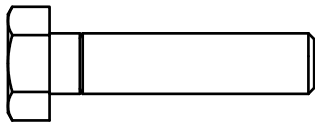

(A2)HEX BOLT M8X35L PARTIAL THREAD QTY.4

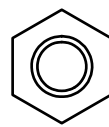
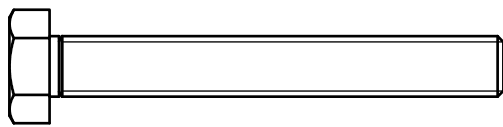

(A3)HEX BOLT M8X60L PARTIAL THREAD QTY.4

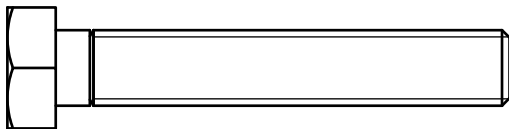

(A4)HEX BOLT M10X60L PARTIAL THREAD QTY.4

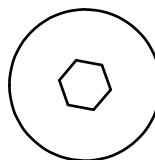
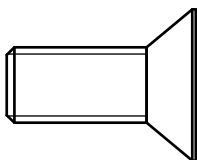

(A5)M10X25L SOCKER FLAT HEAD SCREW QTY.2

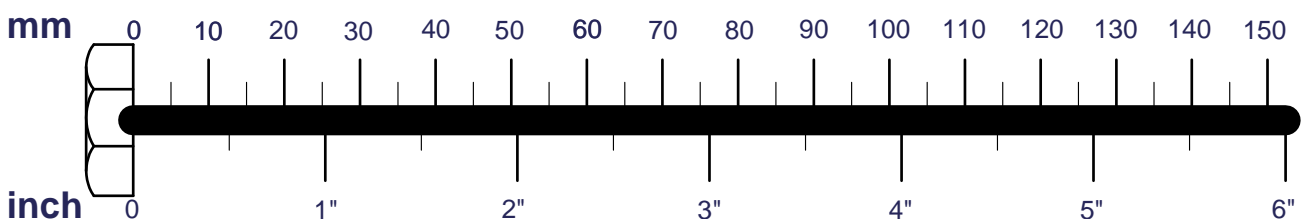

# CPD-800 ASSEMBLY INSTRUCTIONS

## HARDWARE ILLUSTRATION

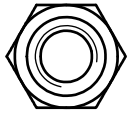

(B1) NYLON LOCK NUT M8 QTY.2

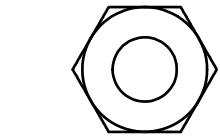
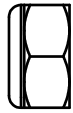

(B2) NYLON LOCK NUT M10 QTY.4

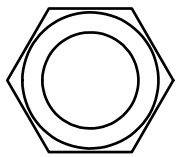

(B4) NYLON LOCK NUT 1/2" QTY.2

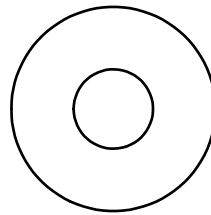
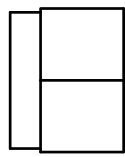

(C5) M10(I.D.) FLAT WASHER Ø27X2T QTY.4

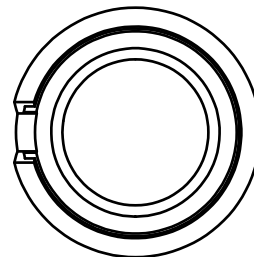
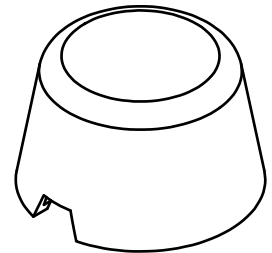
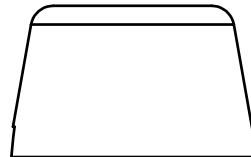
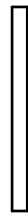

(C6) 1/2" BOLT CAP(9212-024) QTY.4

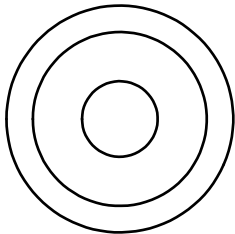

(C1) 3/8" ROUND END CAP WASHER QTY.4

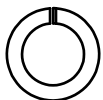
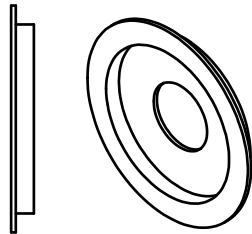

(C2) M8 SPRING WASHER QTY.8

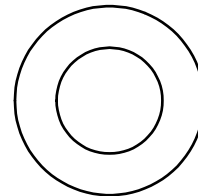

(C7) 1/2"(I.D.) FLAT WASHER Ø25X3T QTY.2

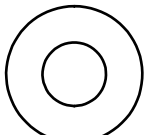

(C3) M8(I.D.) FLAT WASHER Ø18X1.5T QTY.4

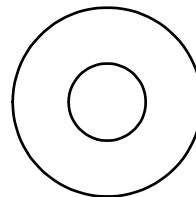

(C8) M10(I.D.) FLAT WASHER Ø25X2T QTY.1

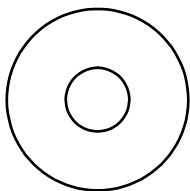
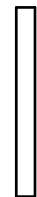

(C4) M8(I.D.) FLAT WASHER Ø24X1.5T QTY.8

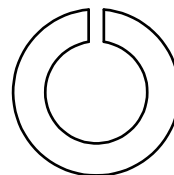

(C9) 1/2" SPRING WASHER QTY.2

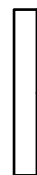

mm

0 10 20 30 40 50 60 70 80 90 100 110 120 130 140 150

inch

0 1" 2" 3" 4" 5" 6"

# CPD-800 ASSEMBLY INSTRUCTIONS

## HARDWARE ILLUSTRATION

- D1.  $\varnothing$ 50X10 END COVER (8130-131)-----[2PCS]
- D2.  $\varnothing$ 1" CU WASHER(8520-008)-----[2PCS]
- D3.  $\square$ 50 ROUND END CAP (9211-087)-----[2PCS]
- D4. 40X80 END CAP(9211-113)-----[3PCS]
- D6.  $\varnothing$ 60X42H DECK BUFFER (9214-037)-----[2PCS]
- D7. 40X80 ROUND END COVER (9261-070)-----[2PCS]
- D8. 40X80 FOOT CAP (9261-071)-----[1PCS]
- D9. 40X80 FOOT CAP (9261-072)-----[1PCS]
- D10. 95X140L RUBBER PAD(9630-003)-----[2PCS]
- D11.  $\varnothing$ 30X27L STOPPER(9310-021)-----[2PCS]
- D13. $\varnothing$ 39.5X3TX $\varnothing$ 20 RUBBER DOUNT(9310-068)-----[2PCS]
- D14. $\varnothing$ 16X22.5L STEEL BUSHING(8110-090)-----[2PCS]

D1

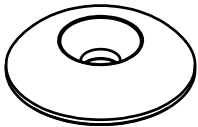

D2



D3

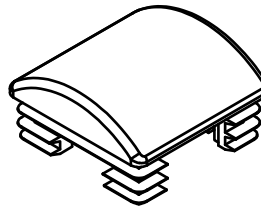

D4

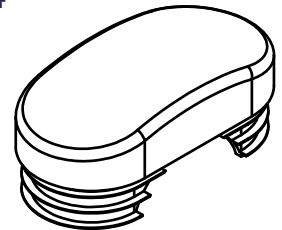

D6

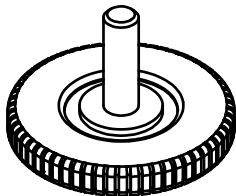

D7

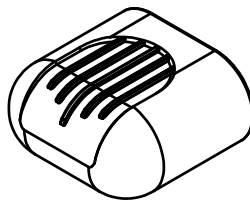

D8

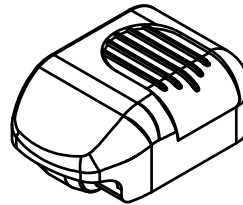

D9

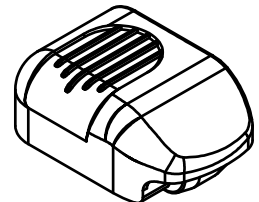

D10

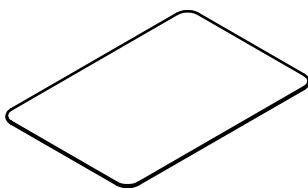

D11

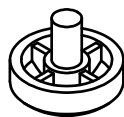

D13

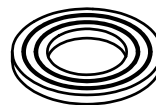

D14

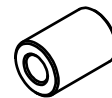

# CPD-800 ASSEMBLY INSTRUCTIONS

## PARTS ILLUSTRATION SHEET

A1[1PCS]

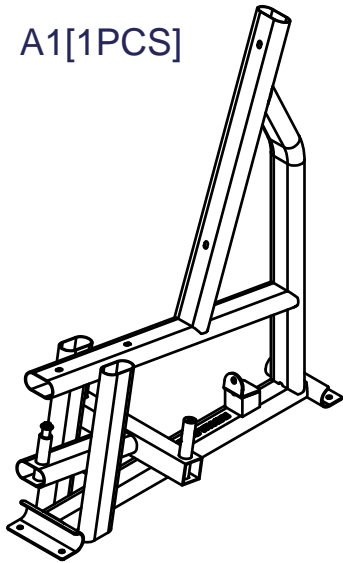

B1[1PCS]

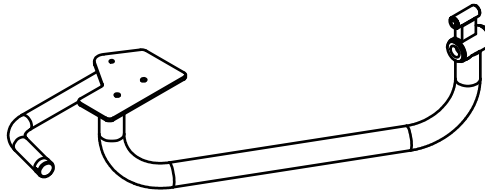

Q[1PCS]

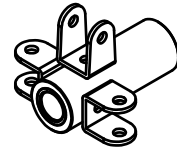

C1[1PCS]

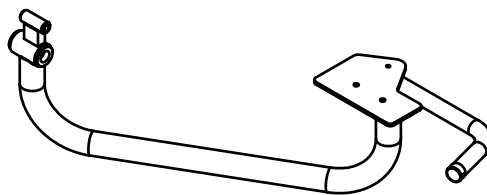

D1[2PCS]

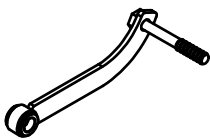

F[1PCS]



O[1PCS]  
8220-162  
Ø20X260L

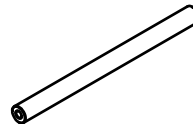

P[1PCS]  
8343-211  
90X5TX87.5

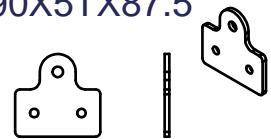

G[1PCS]  
5584-K007  
40X80X2TX600L

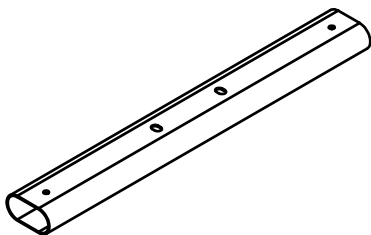

H[1PCS]  
5584-K008  
40X80X2TX600L

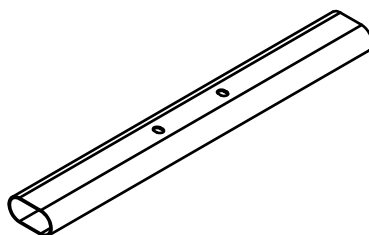

I[2PCS]  
8386-101

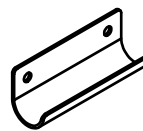

J[1PCS]  
8830-018

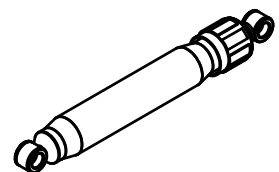

K[1PCS]  
9111-065



L[1PCS]  
9121-064

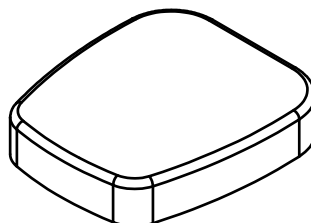

M[2PCS]  
9131-021

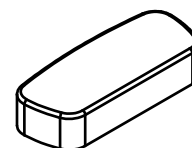

# CPD-800 ASSEMBLY INSTRUCTIONS

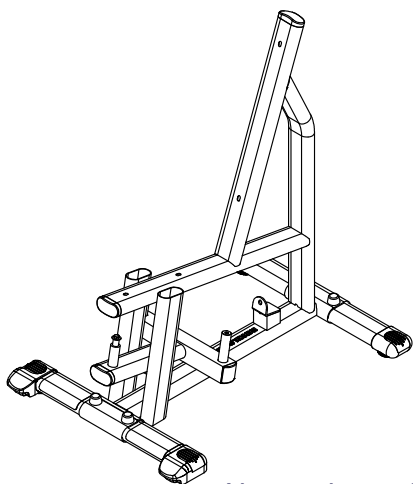

Above shows STEP 1  
assembled and completed

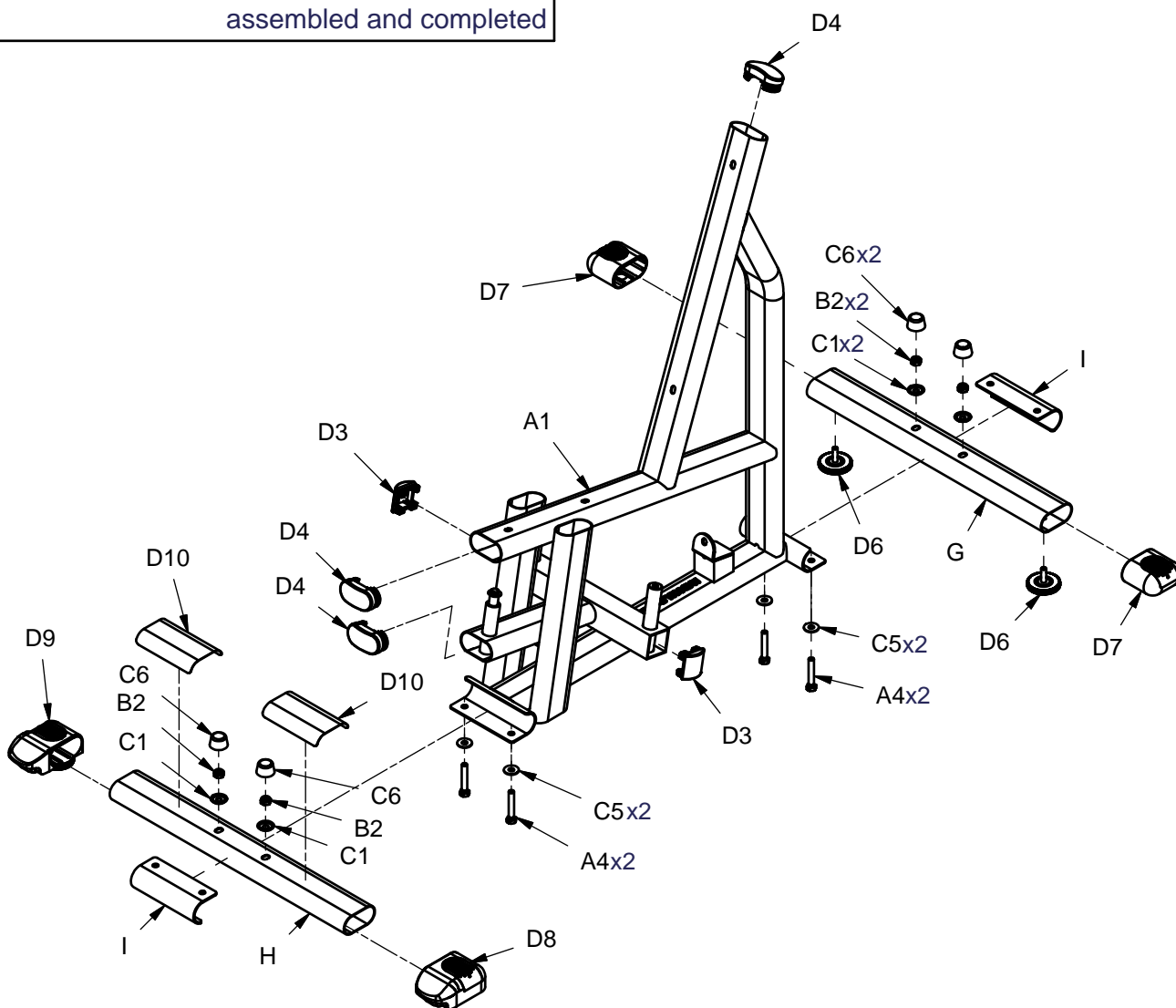

# CPD-800 ASSEMBLY INSTRUCTIONS

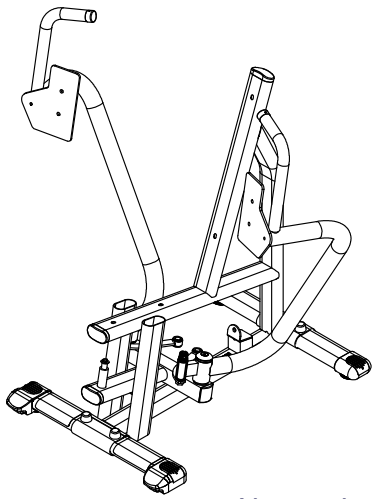

Above shows STEP 2  
assembled and completed

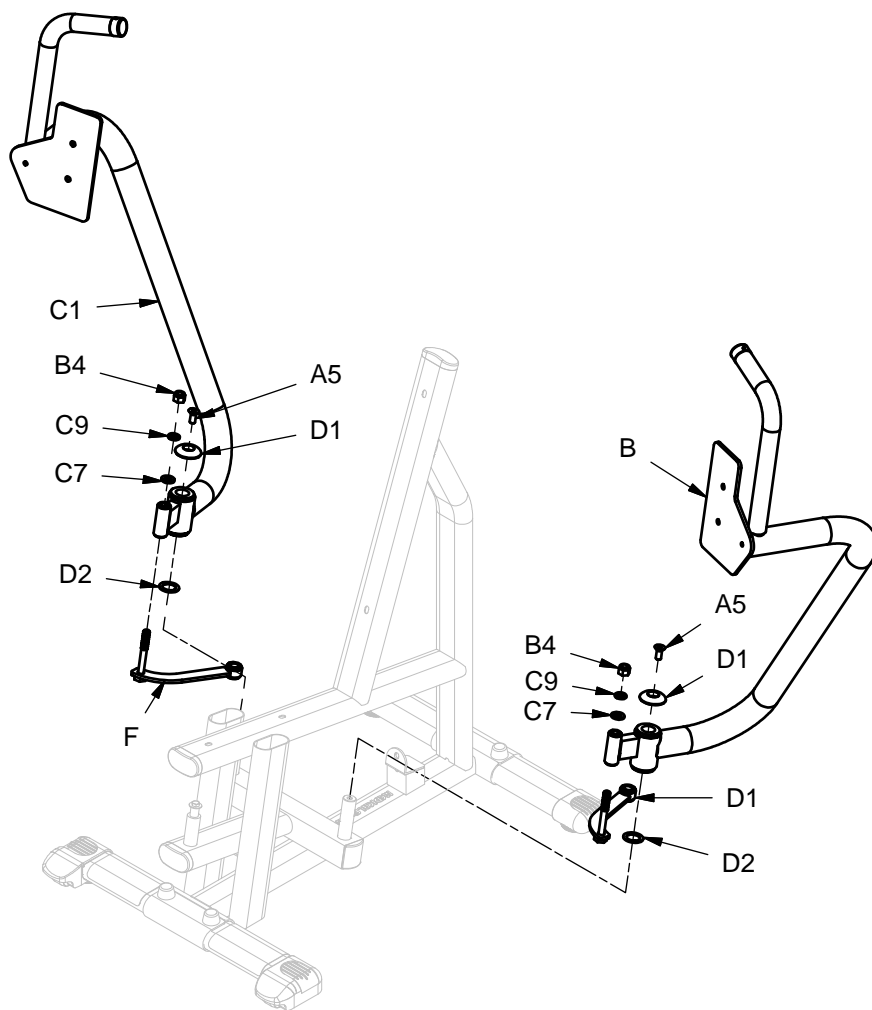

# CPD-800 ASSEMBLY INSTRUCTIONS

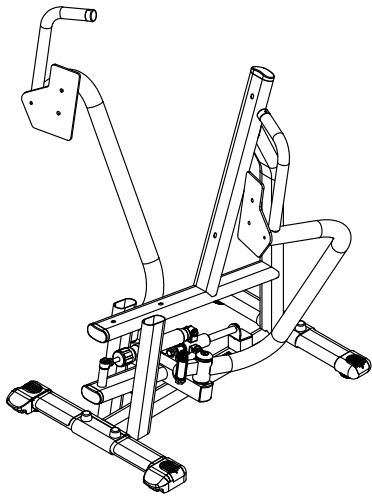

Above shows STEP 3 assembled and completed

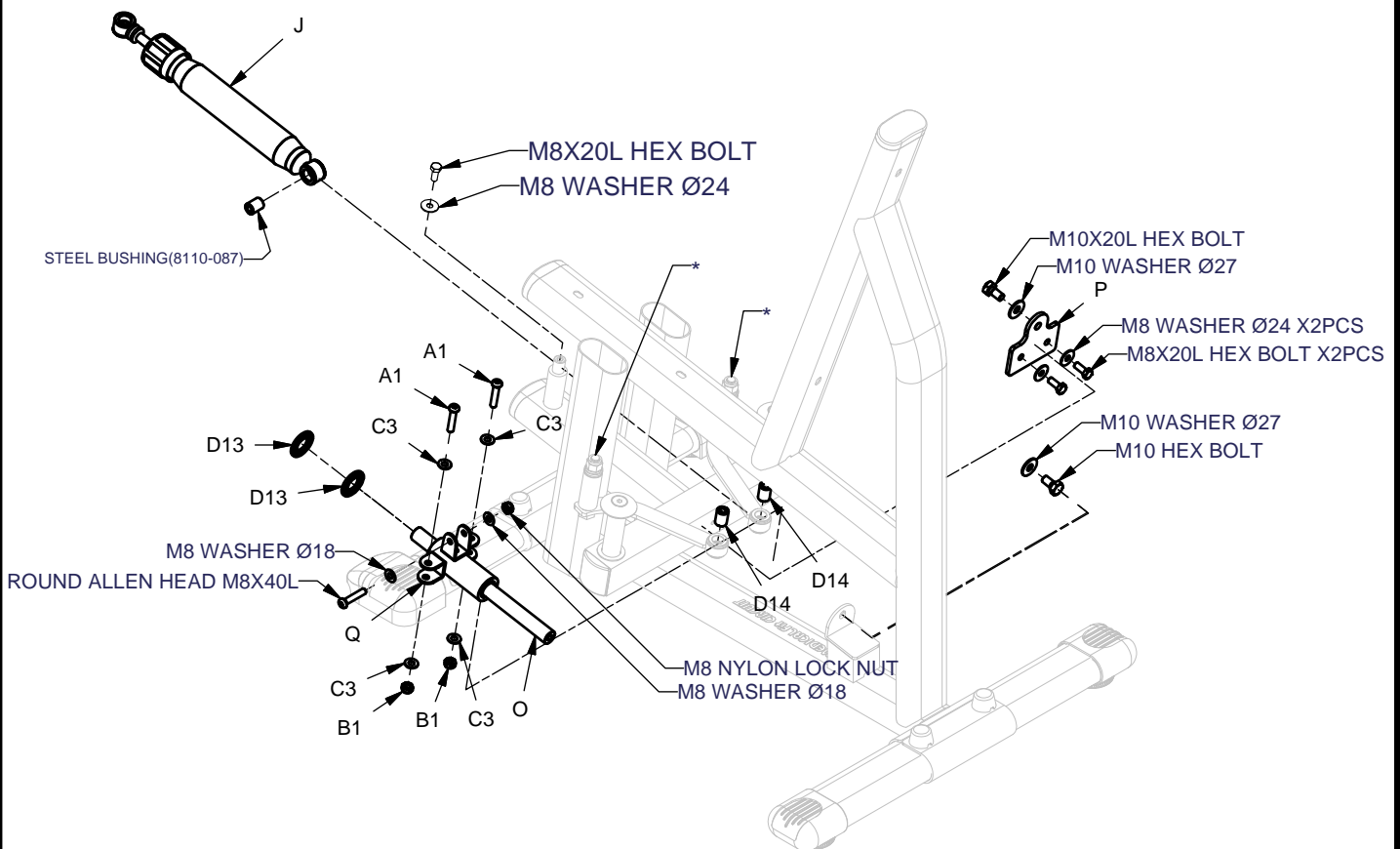

\* : Tighten the nylon locknut until it fixed, and loosen it 1/4 circle in order to avoid too tight nylon locknut influencing the machine movement.



# CPD-800 ASSEMBLY INSTRUCTIONS

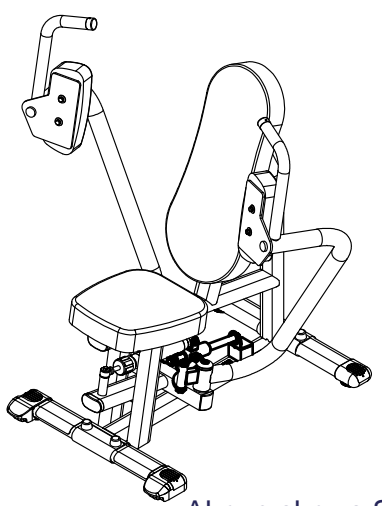

Above shows STEP 4 assembled and completed

