

# SteelFlex

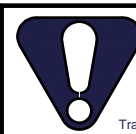
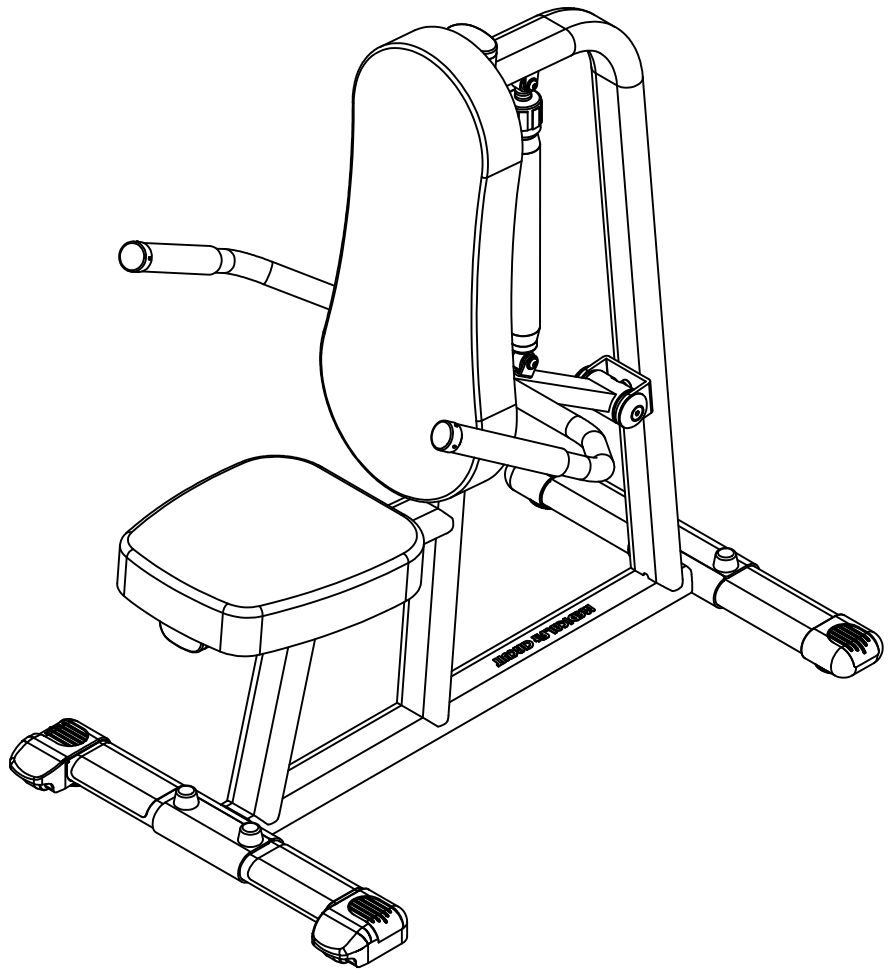

The Surgeon General  
has determined that lack  
of physical activity is  
detrimental to your health.™

Trademark of United States Fitness Products Council

**THERE IS A RISK ASSUMED BY INDIVIDUALS WHO USE THIS TYPE OF EQUIPMENT. TO MINIMIZE RISK, YOU MUST FOLLOW THESE RULES:**

1. Inspect equipment before each workout. Check that all nuts, bolts, screws and pop pins are in place and fully tightened. Also, before use, check cylinders for leaking. Replace all worn parts immediately. Never use machine if any parts are damaged or missing. Failure to follow these rules may result in serious injury.
2. Keep clear of the cylinder and all moving parts when the machine is in use.
3. Exercise with care. Perform your exercises at a smooth moderate pace; never perform jerky or uncoordinated movements that may cause injury.
4. It is recommended that you should workout with a training partner.
5. Do not allow children or minors to play on or around this equipment.
6. If unsure of proper use of equipment, call your local distributor.
7. **WARNING:** Consult your physician before starting your exercise program. For your own safety do not begin any exercise program without proper instruction.

## CAC-700 OWNER'S MANUAL

# CAC-700 ASSEMBLY INSTRUCTIONS

## HARDWARE ILLUSTRATION

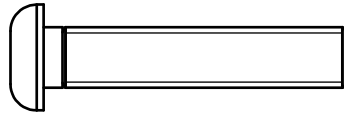
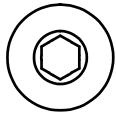

(A1)ROUND INNER HEX SCREW M8X40L PARTIAL QTY.2

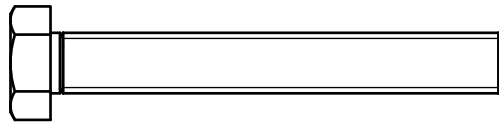
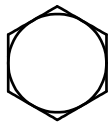

(A2)HEX BOLT M8X60L PARTIAL QTY.4

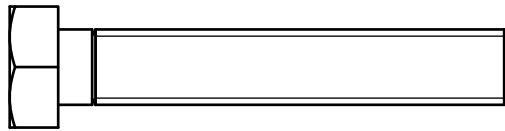
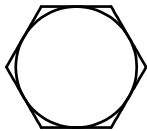

(A3)HEX BOLT M10X60L PARTIAL QTY.4



(A4)BOLT CAP(9212-024) QTY.4

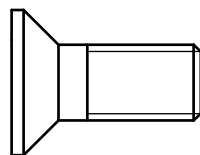
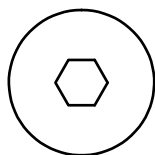

(A5)M10X25L SOCKER FLAT SCREW QTY.2

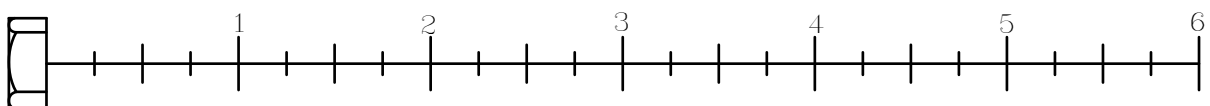

# CAC-700 ASSEMBLY INSTRUCTIONS

## HARDWARE ILLUSTRATION

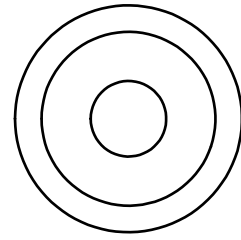
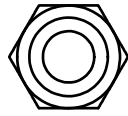

(B1) M8 NYLON LOCK NUT QTY.2 (C4) 3/8" ROUND END CAP WASHER QTY.4

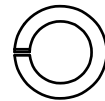
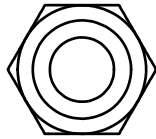
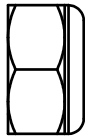

(B2) M10 NYLON LOCK NUT QTY.4 (C5) M8 SPRING WASHER QTY.4

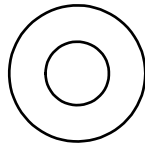

(C1) M8 (I.D.) FLAT WASHER Ø18 QTY.4

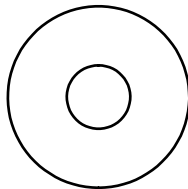

(C2) M8 (I.D.) FLAT WASHER Ø24 QTY.4

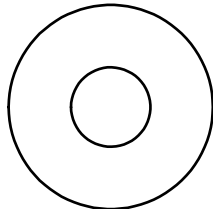

(C3) M10 (I.D.) FLAT WASHER Ø27 QTY.4

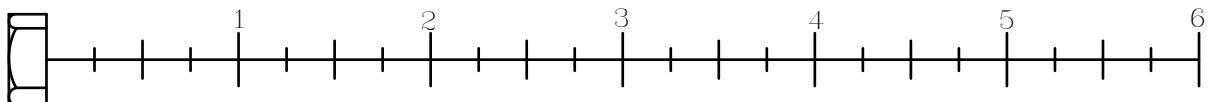

# CAC-700 ASSEMBLY INSTRUCTIONS

## HARDWARE ILLUSTRATION

(D1)Ø50X10 END COVER(8130-131)	-----	[2PCS]
(D2)40X80 END CAP(9211-113)	-----	[2PCS]
(D3)Ø60X42H DECK BUFFER(9214-037)	-----	[2PCS]
(D4)40X80 ROUND END COVER(9261-070)	-----	[2PCS]
(D5)40X80 FOOT CAP(9261-071)	-----	[1PCS]
(D6)40X80 FOOT CAP(9261-072)	-----	[1PCS]
(D7)95X140L RUBBER PAD(9630-003)	-----	[2PCS]

D1.

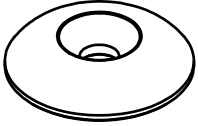

D2.

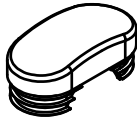

D3.

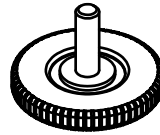

D4.

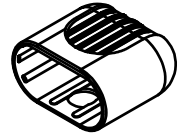

D5.

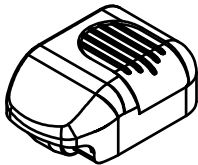

D6.

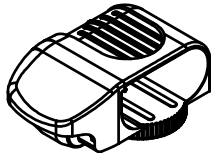

D7.

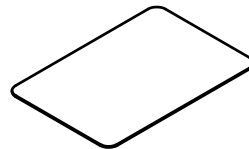

# CAC-700 ASSEMBLY INSTRUCTIONS

## PARTS ILLUSTRATION SHEET

A[1SET]

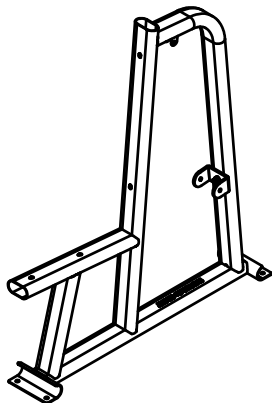

B[1SET]

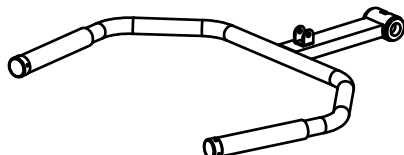

C[1PCS]

5584-K007  
40X80X2tX600L

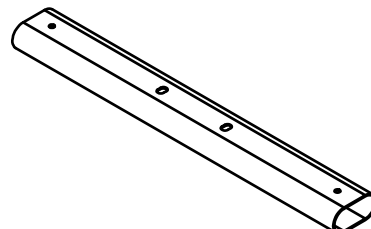

D[1PCS]

5584-K008  
40X80X2tX600L

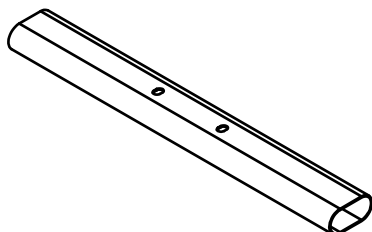

E[1SET]

8220-148  
Ø25.4X73.5L

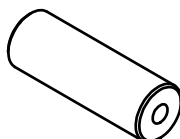

F[2PCS]

8386-101

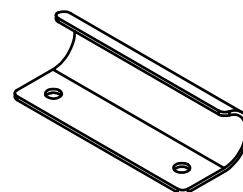

G[1PCS]

8830-017

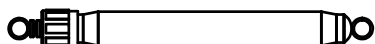

H[1PCS]

9121-064

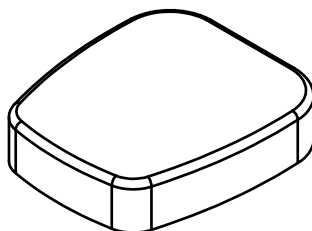

I[1PCS]

9111-065

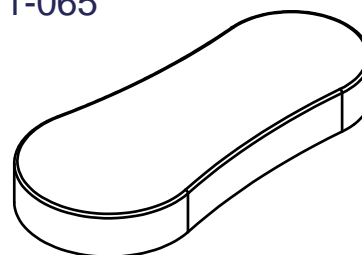

# CAC-700 ASSEMBLY INSTRUCTIONS

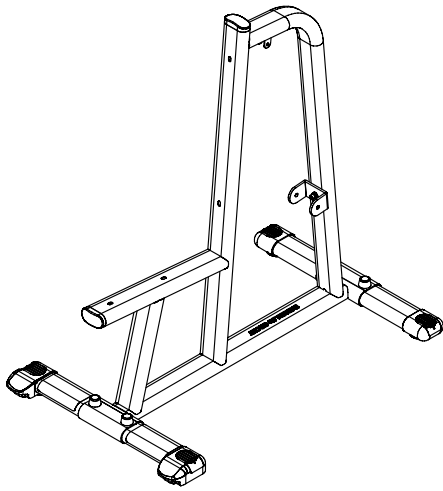

Above shows STEP1  
assembled and completed

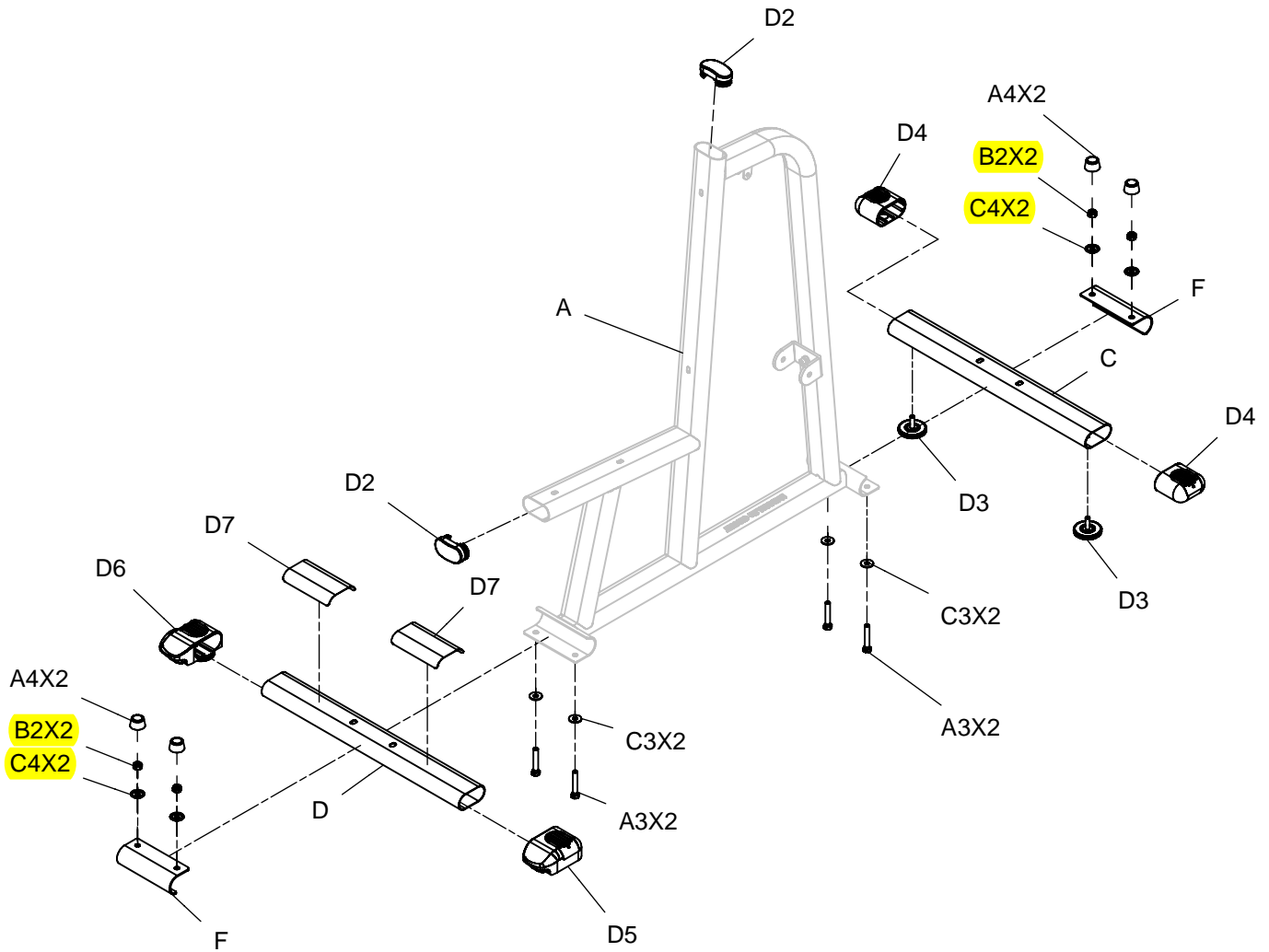

# CAC-700 ASSEMBLY INSTRUCTIONS

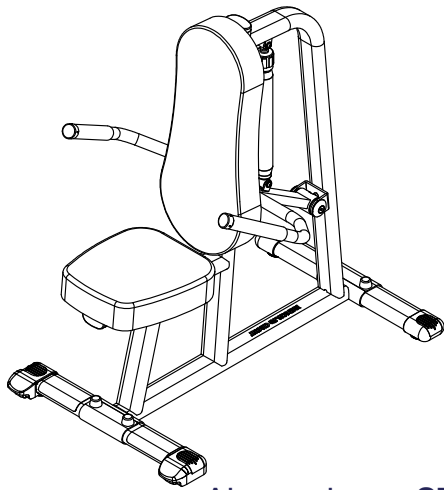

Above shows STEP2 assembled and completed

